

#newideas2023
anemos

pag. 2

babila twist
blume table

pag. 30
pag. 22

frank
guinea

pag. 18
pag. 10

jeff
lamorisse wood

pag. 26
pag. 6

nari
souvenir

pag. 14
pag. 24

2023

new ideas



PEDRALI®



①

Nym Soft side chair Art. 2882

Upholstered side chair, injected foam core, steel tube legs.
Sedia imbottita con gambe in tubo d'acciaio.

②

Anemos Art. ANMD149

Table with concrete base, clay-coloured finish.
Ø 1490 mm solid laminate top, glossy lacquered.
Tavolo con base in cemento finitura argilla.
Ripiano in stratificato laccato lucido Ø 1490 mm.

③

Isotta lamp Art. L007S/A

Pendant lamp, powder-coated aluminium.
Lampada a sospensione in alluminio verniciato.

design:
Pio & Tito Toso

anemos

Sculpted by the wind

EN Anemos is a table characterised by simple and architectural shapes designed to enhance the materiality of concrete. The distinctive feature of Anemos is the base, composed by two separate concrete shells secured to the top. Their double curvature and sinuous shapes recall a structural membrane. The result is a table that seems sculpted by the wind, visually light yet stable and solid due to its significant weight, capable of supporting large tops. The matt and slightly shaded surface of the concrete, natural or clay-coloured, enhances the materiality of the base.

IT Anemos è un tavolo caratterizzato da forme semplici e architettoniche volte ad esaltare la matericità del cemento. Il tratto distintivo di Anemos è la base, formata da due gusci di cemento separati tra loro e fissati al ripiano. La doppia curvatura e le forme sinuose ricordano una membrana strutturale. Il risultato è un tavolo che sembra scolpito dal vento, otticamente leggero ma allo stesso tempo stabile e solido grazie al suo importante peso, capace di supportare ripiani di grandi dimensioni. La superficie opaca e leggermente ombreggiata del cemento, naturale o color argilla esalta la matericità della base.





①

Anemos Art. ANMD139

Outdoor table with concrete base.
 Ø 1390 mm concrete finish table top.
 Tavolo outdoor con base in cemento.
 Ripiano finitura cemento Ø 1390 mm.

②

Lamorisse outdoor armchair Art. 3685

Extruded aluminium frame, seat supported by elastic belts, removable cushion in polyurethane foam.
 Struttura in estruso di alluminio, seduta supportata da cinghie elastiche, cuscino sfoderabile in schiumato poliuretano.



EN Top available in matt or glossy lacquered solid laminate, fenix or concrete finish.

IT Ripiano disponibile in stratificato opaco o laccato lucido, fenix o finitura cemento.



anemos

Ø1590 mm



Ø1490 mm



Ø1390 mm



Ø1290 mm



730 mm

anemos

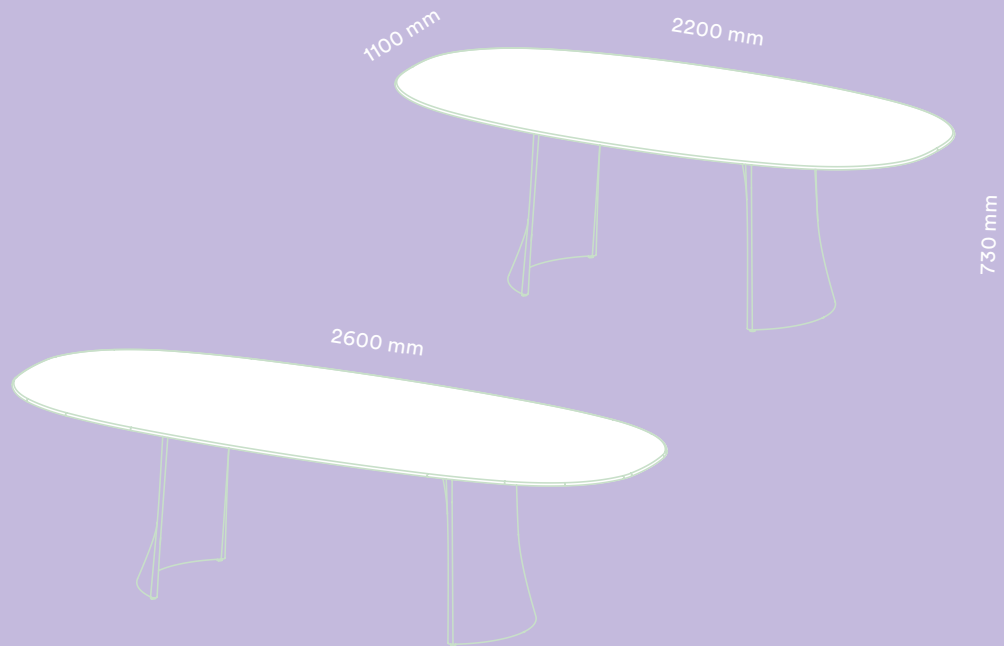

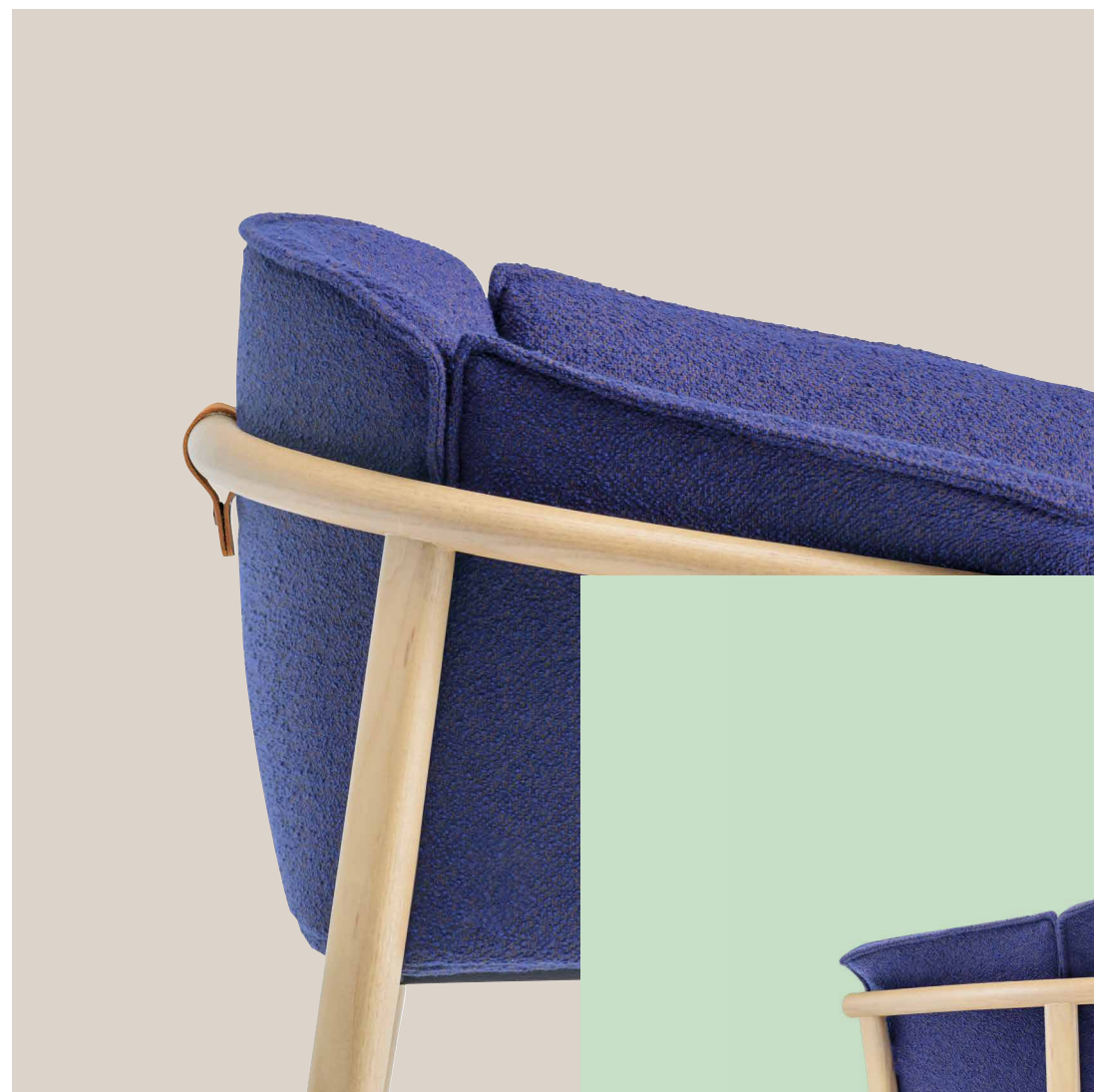

EN The oval shaped legs are thicker near the joints for added strength.

IT Le gambe a sezione ovale aumentano di spessore in prossimità degli innesti per garantire maggiore solidità.



design:
CMP Design

lamorisse wood

Up to the sky!

EN Lamorisse Wood is a solid ash armchair for indoor use. The frame, characterised by oval shaped legs that blend with rounded steam-curved armrests, accommodates a generous and embracing cushion. The main feature is the contrast between the sober shape of the supporting structure and the use of a large and enveloping cushion. This natural evolution springs from the desire to offer the same level of comfort indoors and to provide a complete collection of chairs that can be used in spaces characterised by indoor-outdoor continuity.

IT Lamorisse Wood è una poltrona in massello di frassino per ambienti indoor. La struttura, con bracciolo a sezione rotonda in frassino curvato al vapore nel quale si innestano le gambe, accoglie un cuscino generoso e avvolgente. La caratteristica principale è il contrasto tra la struttura portante, dalla forma sobria, ed il cuscino ricco e accogliente. Questa naturale evoluzione nasce dalla volontà di portare lo stesso comfort anche negli ambienti interni e permette di avere una collezione completa di sedute utilizzabile in tutti gli spazi caratterizzati da una continuità tra indoor e outdoor.



①

Lamorisse Wood Art. 3686

Solid ash armchair FSC® C114358 certified.
Poltrona in frassino certificato FSC® C114358.

②

Aero table Art. TAE130X130

Steel central base table. Fenix top.
Tavolo con base centrale in acciaio. Ripiano in fenix.

③

L002 lamp Art. L002T/BA

Floor lamp with injection moulded polycarbonate diffuser. Steel base and stem.
Lampada da terra con diffusore in policarbonato. Base e stelo in acciaio.



EN Non-deformable injected polyurethane foam seat and backrest.

IT Seduta e schienale in schiumato poliuretano indeformabile.

EN A hard leather strap secures the backrest to the frame.

IT Una fascetta in cuoio fissa lo schienale alla struttura.



Lamorisse Wood Art. 3687

Seat supported by elastic belts. Cushions also on armrests, removable fabric.
Seduta supportata da cinghie elastiche. Imbottitura anche sui braccioli, rivestimento sfoderabile.



①

Toa table Art. TOA300X100

Die-cast aluminium outdoor table, solid laminate top.
Tavolo per esterno in pressofusione di alluminio,
ripiano in stratificato.

②

Guinea Art. 3695

Armchair with extruded aluminium frame,
textilene seat and backrest, teak armrests.
Poltrona con struttura in estruso di alluminio,
seduta e schienale in textilene, braccioli in teak.

design:
CMP Design

guinea

guinea

A tropical allure

EN Guinea is an aluminium outdoor armchair with an iconic allure that evokes the concept of lightness and transparency. The aluminium frame combines with a seat in waterproof textilene on which rests a soft, removable cushion. Guinea can be customised in various configurations: the version with a textilene backrest is reminiscent of the traditional director's chairs, the version with the backrest in aluminium slats features more traditional, archetypical forms.

IT Guinea è una poltrona in alluminio per outdoor che suggerisce un'idea di leggerezza fisica e visiva oltre che iconica. La struttura portante in alluminio è abbinata ad una seduta realizzata in textilene impermeabile sulla quale appoggia un soffice cuscino removibile. Guinea può essere personalizzata con diverse configurazioni: la versione con schienale in textilene ricorda le tradizionali sedie da regista, la versione con schienale con doghe in alluminio è definita da forme più tradizionali e archetipe.



EN Teak armrests, oil treated.

IT Braccioli in teak trattato all'olio.

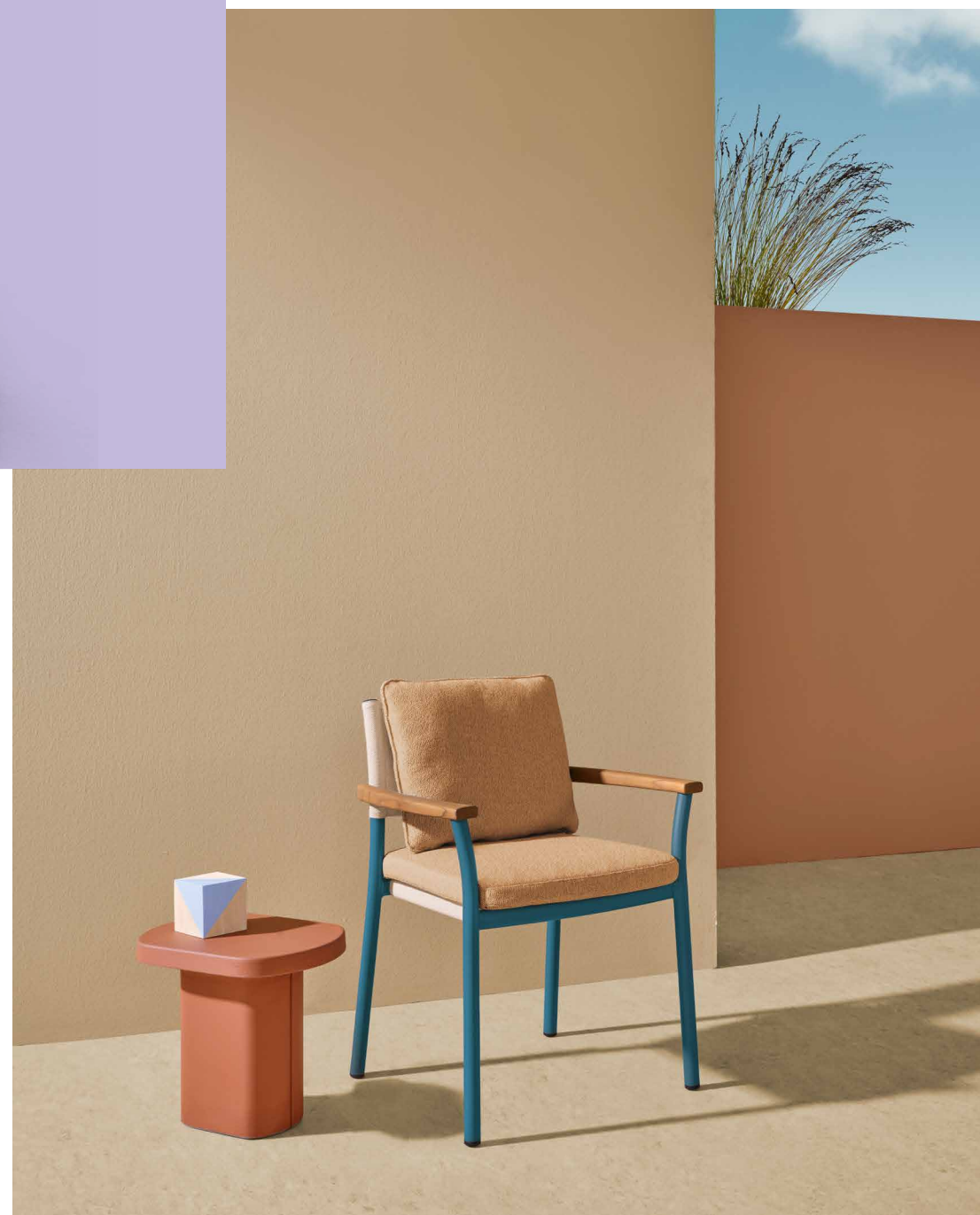

EN Textilene backrest with optional cushion.

IT Schienale in textilene con cuscino accessorio.



EN Guinea armchair with aluminium slats back.

IT Poltrona Guinea con schienale a doghe in alluminio.

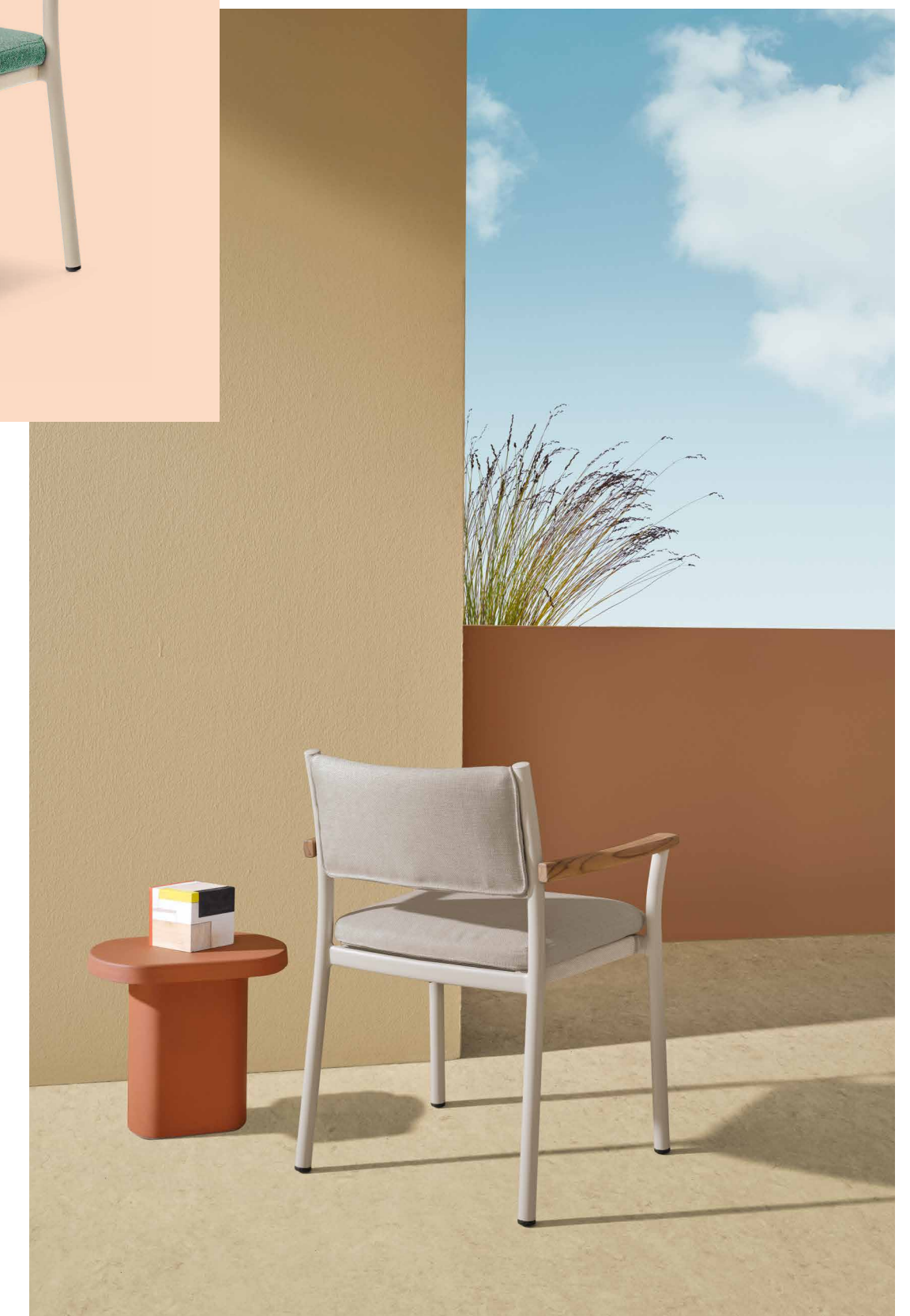

EN Aluminium backrest with slats, upholstered.

IT Schienale a doghe in alluminio rivestito.

guinea

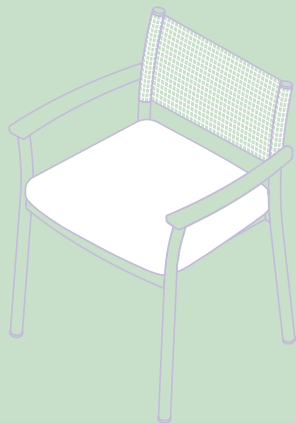

Art. 3695

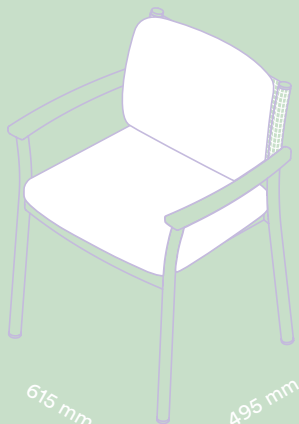

615 mm

495 mm

785 mm

Art. 3675.8

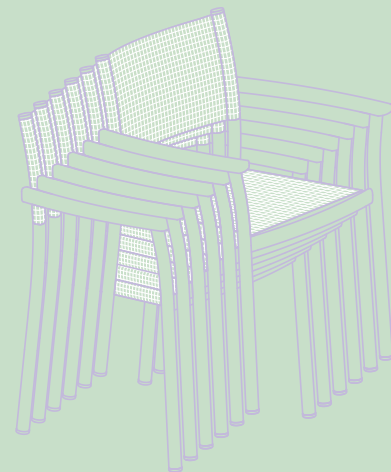
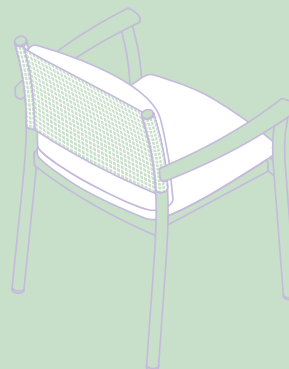

guinea

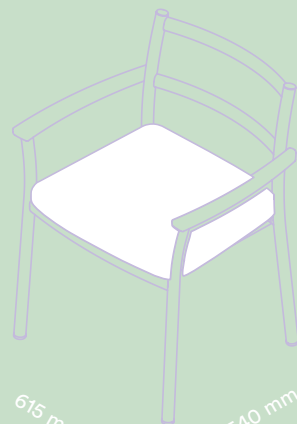
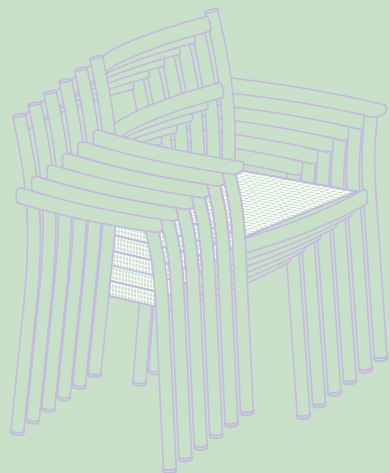

Art. 3694



Art. 3694.5



nari

design:
Andrea Pedrali

①

Elliot table Art. 5477

Aluminium table with Ø 1200 mm porcelain stoneware top.
Tavolo in alluminio con ripiano in gres porcellanato Ø 1200 mm.

②

Nari Art. 6360

Outdoor steel armchair, woven in PVC cord. Cushion covered with fabric for outdoor use.
Poltrona in acciaio per esterno, intreccio in estruso di PVC. Cuscino rivestito con tessuti per outdoor.



Nari Art. 6360

The seat and backrest accommodate a comfortable polyurethane foam cushion consisting of two sections joined by a zip. Removable cushion cover. Seduta e schienale accolgono un cuscino in schiumato poliuretano composto da due sezioni unite da una zip. Rivestimento sfoderabile.



EN Woven in extruded PVC with a nylon core. Available in brown, honey, green, beige.

IT Intreccio in estruso di PVC con anima in nylon. Disponibile marrone, miele, verde, beige.

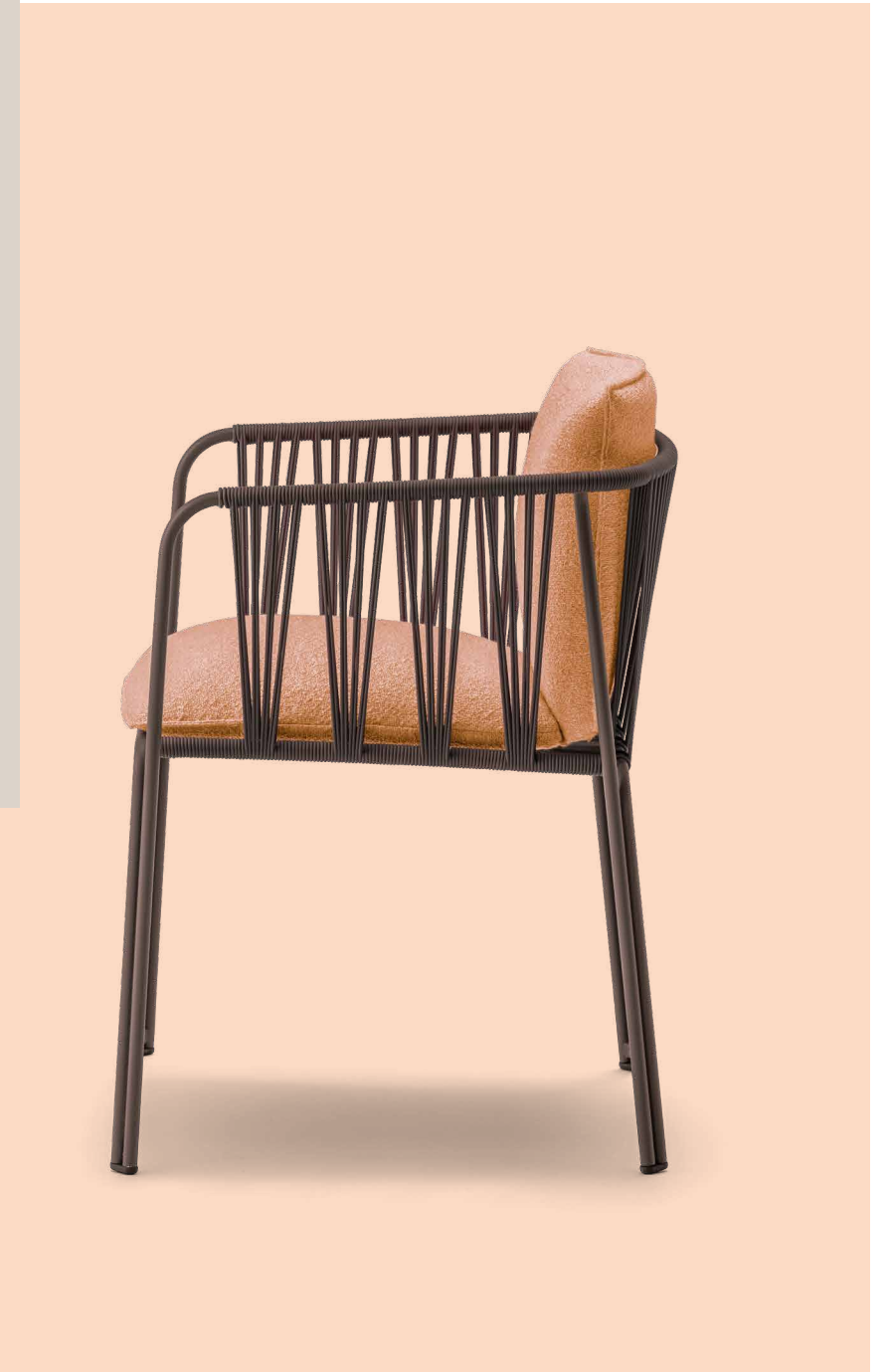

nari

A family tradition

EN Nari echoes some of the elements of the first forged iron garden chairs from Pedrali's 1960s collection, in a contemporary key. The distinctive feature of the legs, obtained from a double rod forged by hand and bent, is evoked using a double steel tube that features a simpler, more linear shape. This woven element, created in Italy by expert craftsmen, tightens towards the lower part of the seat and widens towards the top, calling to mind the fan-shaped geometry inspired by the backrest of the Serenella armchair. A tribute of the designer to his grandfather Mario Pedrali, founder of the company.

IT Nari riprende alcuni degli elementi delle prime sedie da giardino realizzate in ferro battuto presenti nella collezione Pedrali degli anni Sessanta, reinterpretandoli in chiave contemporanea. L'elemento distintivo delle gambe, ottenute da un doppio tondino forgiato a mano e piegato, viene rievocato ora attraverso l'utilizzo di un doppio tubo d'acciaio dalla forma più lineare e semplice. L'incordatura, realizzata in Italia da esperti artigiani, si stringe nella parte inferiore della seduta e si allarga verso l'alto per richiamare la geometria a ventaglio ispirata allo schienale della poltrona Serenella. Un tributo del designer al nonno Mario Pedrali, fondatore dell'azienda.



frank

design:
Robin Rizzini

①

Héra armchair Art. 2865

Ash wood armchair with three-dimensional curved plywood backrest and upholstered seat.
Poltrona in frassino con schienale in multistrato curvato tridimensionale e seduta imbottita.

②

Frank Art. TFK280X110

Die-cast aluminium bases, glossy lacquered top.
2800x1100 mm.
Basi in pressofusione di alluminio e ripiano laccato lucido. 2800x1100 mm.

③

L004 lamp Art. L004SW/A

Pendant lamp with injection moulded polycarbonate diffuser.
Lampada a sospensione con diffusore in policarbonato.



Frank Art. TFK280X110

The die-cast aluminium bases are connected by a sturdy steel beam, placed under the top.
Le basi in pressofusione di alluminio sono collegate da una robusta trave in acciaio posta sotto al ripiano.

frank

Architectural illusion

EN Frank is a table inspired by architectural shapes and industrial materials. The structure on which the top rests is made up of two slightly curved die-cast aluminium bases with variable thickness. Seen from the front they are slightly arched and resemble the shape of a sail, creating a light and ethereal optical effect. Seen from the side, the volume appears full. The bases taper towards the bottom, reaching the ground in a less accentuated curve. Together, rational lines and curves contribute to conveying an image of lightness and contemporaneity.

IT Frank è un tavolo ispirato da forme architettoniche e materiali industriali. La struttura su cui appoggia il ripiano è composta da due basi in pressofusione di alluminio dallo spessore variabile leggermente curve. Viste frontalmente richiamano la forma di una vela che, leggermente inarcate creano un effetto ottico leggero ed etereo. Osservate lateralmente il loro volume appare pieno. Rastremate verso il fondo, confluiscono a terra in una curva meno accentuata. Linee razionali e curve insieme contribuiscono a trasmettere un'immagine di leggerezza e contemporaneità al tempo stesso.



EN Soft-shaped top with rounded corners available in lacquered MDF, lacquered glass, fenix, solid laminate.

IT Ripiano con angoli raggati dalle forme morbide disponibile in MDF laccato, vetro laccato, fenix, stratificato.



frank

2200 mm

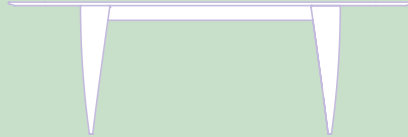

1000 mm



700 mm

2800 mm

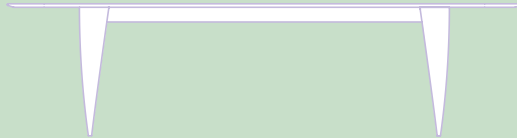

1100 mm



700 mm

3400 mm

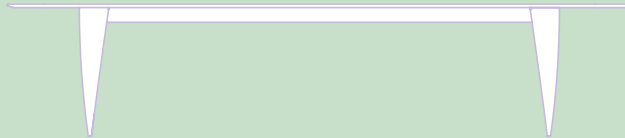

1200 mm



700 mm

725 mm



EN Column in extruded aluminium with a flower shaped profile.

IT Colonna in estruso di alluminio dalla silhouette a forma di fiore.



design:
Sebastian Herkner

blume table

Flower silhouette

EN Blume table echoes the fine lines of the family, whose distinctive force emerges from the column in extruded aluminium with a sophisticated flower-shaped profile featuring along its entire height, for a unique style. The aluminium is anodised in various finishes or powder-coated in a variety of colours. This, combined with tops in composite marble or more innovative materials, allows for utmost customisation and versatility, endowing the table with a modern decorative appeal.

IT Il tavolo Blume riprende le linee ricercate della famiglia la cui forza distintiva emerge dalla colonna realizzata in estruso di alluminio dalla sofisticata silhouette a forma di fiore che, correndo lungo la sua altezza, dona uno stile inconfondibile. Diverse anodizzazioni dell'alluminio e colori di verniciatura, abbinati a ripiani in agglomerato di marmo o in materiali più innovativi, esprimono massima versatilità, conferendo al tavolo un aspetto decorativo moderno.



①

Blume side chair Art. 2950

Upholstered chair with extruded aluminium frame.
Sedia imbottita con struttura in estruso di alluminio.

②

Blume table Art. 5511

Stainless steel base Ø 400 mm, extruded aluminium column. Perlato Royal composite marble top.
Base in acciaio inox Ø 400 mm, colonna in estruso di alluminio. Ripiano in agglomerato di marmo Perlato Royal.

③

Tamara lamp L005S/A

Pendant lamp in powder-coated aluminium.
Lampada a sospensione in alluminio verniciato.



①

Elliot table Art. 5470

Aluminium table, powder-coated steel top.
Tavolo in alluminio, ripiano in acciaio verniciato.

②

Souvenir armchair and side chair Art. 555 + 550

Stackable armchair and side chair in polypropylene.
Poltrona e sedia impilabili in polipropilene.

EN Colours:
white, green, light grey, black, pink, red, recycled grey.

IT Colori:
bianco, verde, grigio chiaro, nero, rosa, rosso,
grigio riciclato.



EN 100% recycled polypropylene: 50%
post-consumer waste, 50% post-industrial waste.

IT 100% polipropilene riciclato: 50% scarto post
consumo, 50% scarto post industriale.



design:
Eugeni Quitllet

souvenir

Elegance and memory

EN Souvenir was born from the desire to reinterpret the iconic shapes of the chairs used in Parisian gardens in the 18th century. The innovation is given not only by the material, a polypropylene monoblock, but also by the sinuous curves of the armrest and legs. The three-dimensionality of the seat and backrest make the chair very ergonomic. The legs flow into a characteristic foot reminiscent of forged iron.

IT Souvenir nasce dalla volontà di reinterpretare le forme iconiche delle sedie che nel XVIII secolo venivano usate nei giardini parigini. L'innovazione è data, oltre che dal materiale, un monoblocco in polipropilene, anche dalle caratteristiche curve sinuose del bracciolo e delle gambe. La tridimensionalità della seduta e dello schienale rendono la seduta molto ergonomica. Le gambe confluiscono in un caratteristico piedino che ricorda il ferro forgiato.



jeff

design:
Patrick Norguet

①

Jeff sofa
Art. JEFF004+JEFF003+JEFF001+JEFF007

Modular sofa system in polyurethane foam.
Sistema di divani modulare e componibile
in schiumato poliuretano.

②

Blume coffee tables
Art. BLT_69X69X30+BLTD_49X37

Coffee tables with extruded aluminium frame
and composite marble tops.
Tavolini con struttura in estruso di alluminio
e ripiani in agglomerato di marmo.

③

Blume System
Art. BLS4_105X32X126

Shelving system with extruded aluminium frame
and composite marble, fenix or solid laminate shelves.
Sistema di librerie con struttura in estruso di alluminio e
mensole in agglomerato di marmo, fenix o stratificato.

jeff

Shaping comfort

EN Jeff is a contemporary modular sofa system. It is designed as a set of miniature architectures, skilfully combined to create multiple modular and reconfigurable scenarios. Linear or corner elements (120° or 90°) combine with chaise longues and end pieces, all with or without armrests, allowing for the creation of different configurations, from the most classic corner solutions to the most modern island set-ups. The distinguishing feature of Jeff is its harmony of volumes: the squared backrest combined with a delicate seat to soften and give balance to the whole structure. As an accessory, decorative cushions are available in different shapes: rectangular, square and round.

IT Jeff è un sistema di divani modulare e componibile dal carattere contemporaneo. È progettato come un insieme di piccole architetture che, combinate tra loro, danno vita a molteplici scenari componibili e riconfigurabili. Questi elementi possono essere lineari, ad angolo 120° o 90°, chaise longue e terminali con o senza bracciolo e consentono la creazione di diverse configurazioni: dalle più classiche soluzioni angolari alle più moderne soluzioni a isola. Elemento caratterizzante di Jeff è l'armonia dei volumi: forme squadrate sono abbinata a curve delicate capaci di ammorbidire e donare equilibrio all'insieme. Come accessorio sono disponibili cuscini decorativi in diverse forme: rettangolare, quadrata e tonda.



EN Tone-on-tone piping. Removable lining.

IT Bordino tono su tono. Rivestimento sfoderabile.

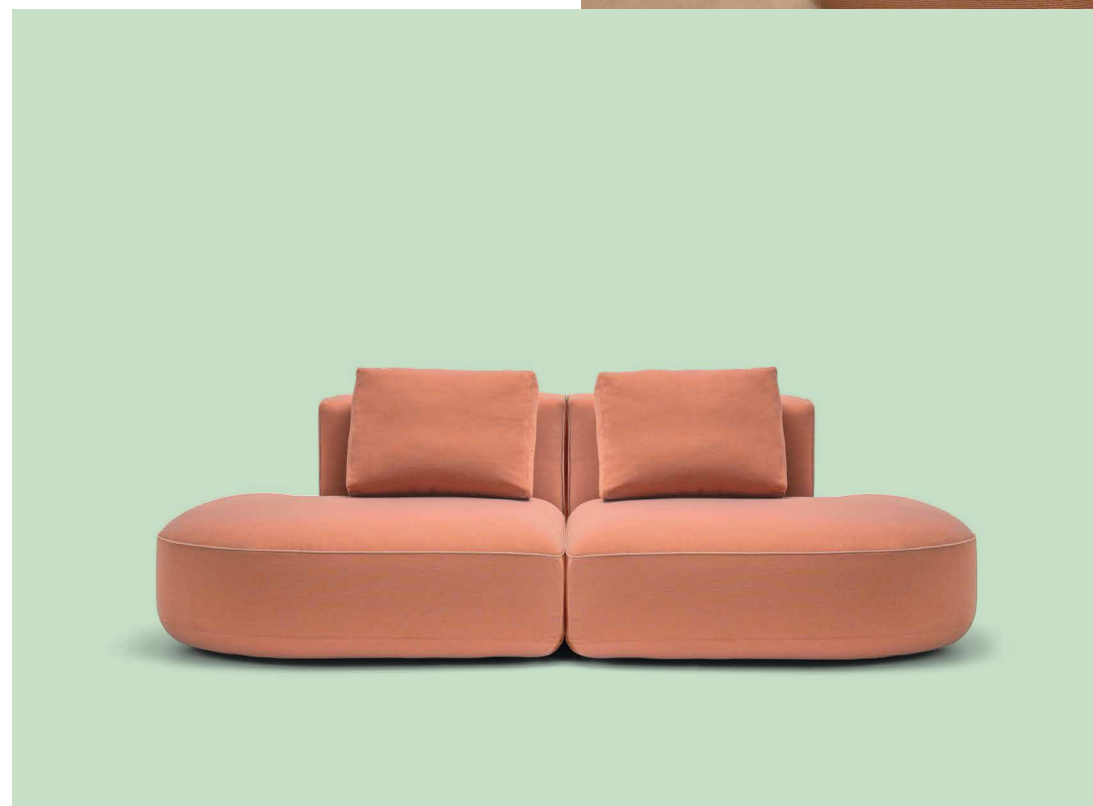

①

Caementum coffee tables
Art. CMT_46X35X42+CMT_40X30X35

Monoblock concrete coffee tables.
Tavolini monoblocco in cemento.

②

Jeff sofa
Art. JEFF010

120° corner element perfect for small waiting areas.
Modulo angolare 120° perfetto per piccole zone d'attesa.

jeff

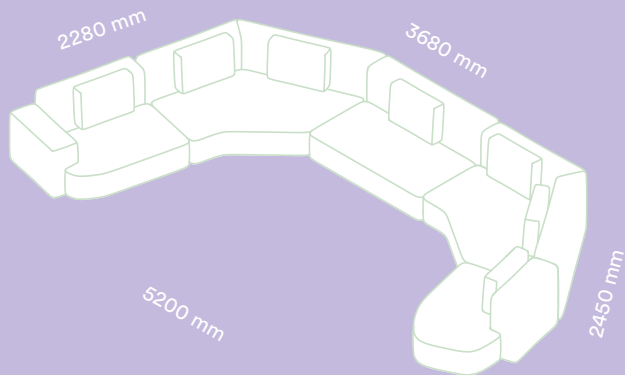
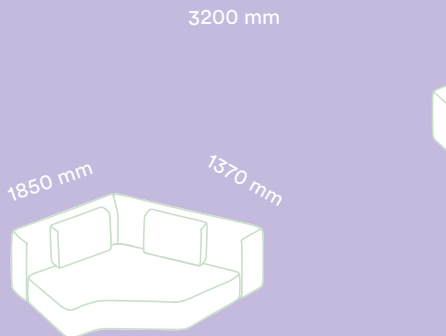
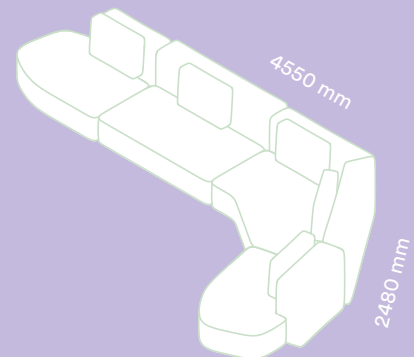
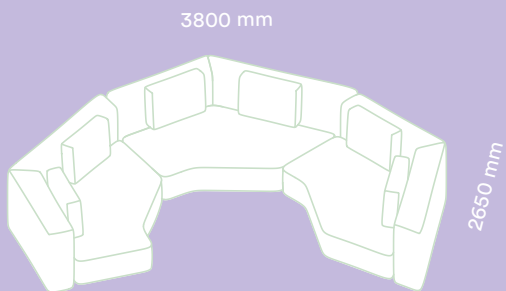
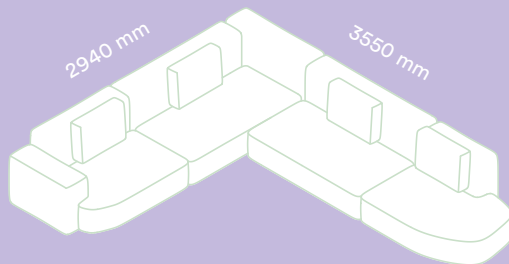

jeff

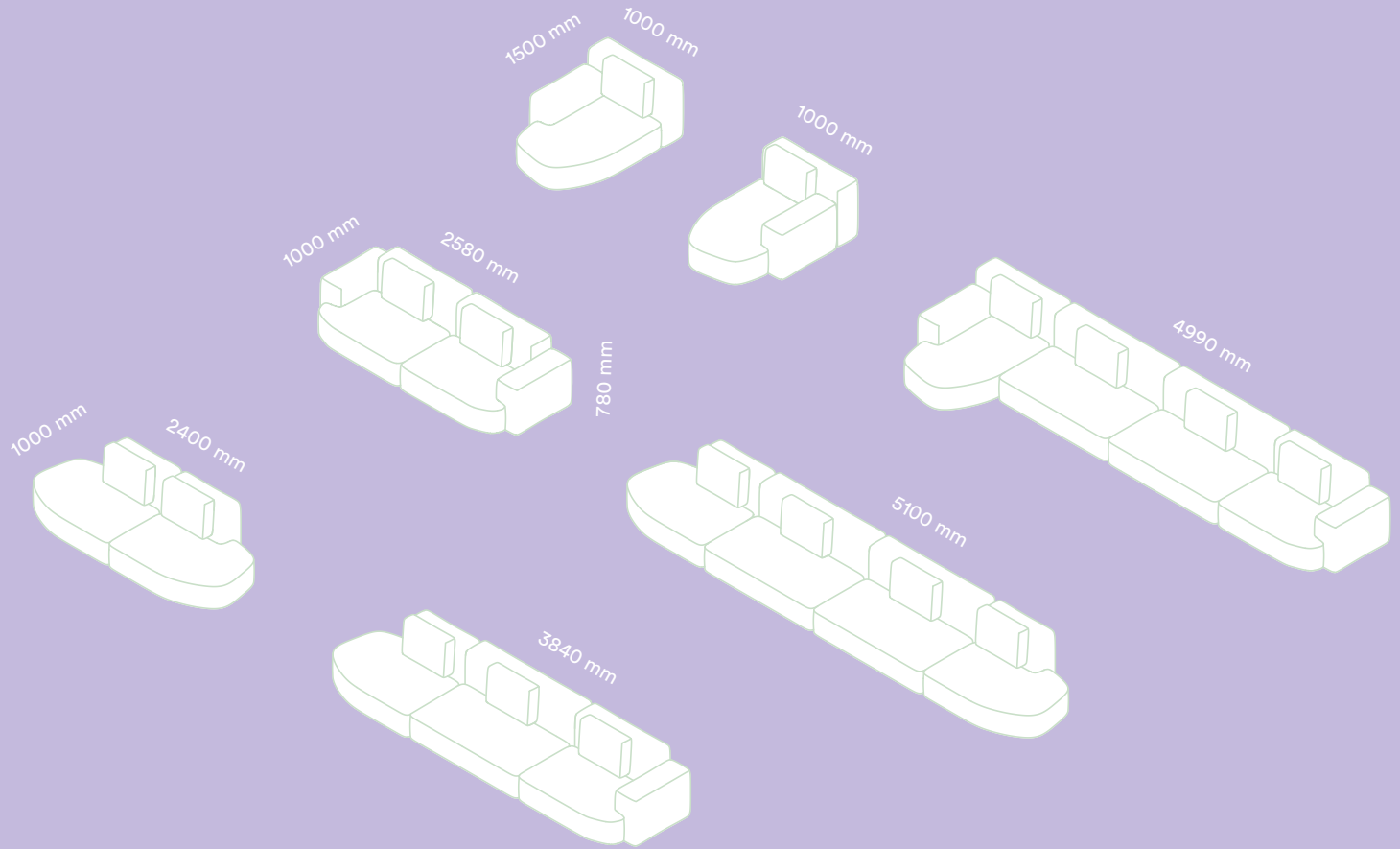



Babila Twist Art. 2795

Woven armchair for outdoor use. Ø 20 mm tubular steel frame and cushion in dry-feel polyurethane foam.
Poltrona intrecciata per outdoor. Struttura in tubo d'acciaio Ø 20 mm e cuscino in poliuretano espanso drenante.

design:
Odo Fioravanti

babila twist

Reloaded memory

EN The distinguishing profile of Babila armchair becomes a steel frame woven with a rope that creates a welcoming space, complemented by a cushion made in weather-resistant materials. Babila Twist is a steel armchair characterised by a large and welcoming shell woven with a flat rope in weather-resistant polypropylene. This weave, handmade in Italy by expert craftsmen, wraps around the armrests and creates a play of light and shadow on the backrest. A comfortable cushion made from dry-feel polyurethane foam that dries quickly, is covered in fabric for outdoor use.

IT La caratteristica sagoma della poltrona Babila si trasforma in un frame di acciaio su cui viene tessuta una corda che crea uno spazio accogliente, finito da un cuscino in materiali adatti a essere esposti agli agenti atmosferici. Babila Twist è una poltroncina in acciaio caratterizzata da una seduta ampia e accogliente, ricoperta da un intreccio realizzato con una corda piatta di polipropilene, resistente agli agenti atmosferici. L'incordatura, realizzata in Italia da esperti artigiani, avvolge anche i braccioli e crea un gioco di luci e ombre sullo schienale. Sulla seduta di Babila Twist appoggia un confortevole cuscino imbottito in poliuretano espanso drenante, capace di asciugare velocemente, rivestito con un tessuto per esterno.



EN Polypropylene cord in different colours: bordeaux, green, beige, dove grey, grey, blue.

IT Corda in polipropilene in diversi colori: bordeaux, verde, beige, tortora, grigio, blu.





Pedrali SpA
Sp 122 Mornico al Serio
24050 Bergamo — Italy
copyright © 2023 Pedrali S.p.A. all rights reserved

export sales department
Italy sales department
website
mail

T +39 035 8358840
T +39 035 8358810
pedrali.com
info@pedrali.it

art direction
styling
photo
still-life photo

studio FM milano
Studio Salaris
Andrea Garuti
Ottavio Tomasini